

# Keysight Technologies

## N9923A FieldFox Handheld RF Vector Network Analyzer

### 4/6 GHz

## Technical Overview



Unlocking Measurement Insights

# World's Most Accurate Handheld Vector Network Analyzer

## FieldFox

The first step in ensuring that wireless communication systems are running at their optimum level is to verify that RF components in the system, such as cables, antennas, and filters are properly tested and kept in good condition. The majority of these tests are conducted in the field or in a warehouse, where bench top instruments are not readily available, testing space is limited, or where a power source is simply not available. The Keysight Technologies, Inc. handheld FieldFox RF Vector Network Analyzer (VNA) is designed to make network analysis measurements in the field easier, convenient, and the most reliable.

## QuickCal revolutionizes calibration in the field

The number one challenge in making accurate network analyzer measurements in the field is reliability, where large temperature fluctuations are common. Keysight's FieldFox RF VNA is the only handheld network analyzer with *QuickCal* technology that allows operators to easily correct for drift errors caused by temperature changes. *QuickCal* is a built-in calibration system that provides worry-free accuracy and reliability. FieldFox's built-in standards make calibration simpler, by eliminating the need to carry mechanical calibration kits into the field.

## Unmatched reliability for day-to-day tests

Whether you are testing a flight line for the air force, an RF system on a war ship, a wireless communication cable and antenna system, tuning RF components, or making other general purpose network analyzer measurements – the FieldFox RF VNA provides unmatched measurement reliability, stability, and efficiency for your every day test needs. The FieldFox RF VNA also builds on Keysight's 40-year legacy of network analysis leadership in calibration, accuracy, and innovation.



## Key measurements

- Full 2-port S-parameters, magnitude and phase
- Time domain with gating
- Full 2-port Cal, TRL, QuickCal
- Cable and antenna test, distance-to-fault, return loss
- Vector voltmeter, 1- and 2-channel
- Power measurements with USB power sensor
- Pulse measurements with USB peak power sensor

## Key differentiators

- Built-in QuickCal enables calibration without a cal kit
- Best measurement stability over time and temperature
- Industry's only handheld network analyzer with MIL PRF 28800F Class 2 compliance with no exceptions
- Easy-to-use, task-driven user interface
- Weather resistant, compact, and field-friendly design, no fan and vents
- Remote control via iOS device





## Pick up FieldFox for its ergonomics





...and depend on its durability and convenience



2.8" D  
72 mm

Test Port 1

External reference  
and external trigger

Test Port 2

Connector bay protects  
RF connectors

Spacious connector design makes  
connections fast and simple

Quick-connect  
shoulder strap clips



Keep going with field-swappable batteries that last up to 3.5 hours

LAN port for data transfer, SCPI programming and remote control from iOS device

Micro SD flash card slot for additional data storage

Headphone jack

Mini USB port connection to PC for SCPI programming!

Gasketed doors protect ports from moisture

USB ports for data transfer, GPS receiver, and USB power sensors

1. SCPI over USB is only available for N9923A with serial number prefix starting with MY5607/SG5607/US5607 and N9923A upgraded with Option N9910HU-500.

## Key Measurements

### Vector Network Analysis

The base FieldFox RF VNA provides transmission/reflection (T/R) measurements, or S11 and S21, with magnitude and phase.

Adding Option 122 (full 2-port S-parameters) brings new levels of accuracy and convenience for testing RF components. A full 2-port network analyzer lets you measure the forward and reverse characteristics of your components without having to disconnect, turn around, and reconnect them to the analyzer.

It also provides full 2-port calibration to give you the best measurement accuracy possible. Depending upon your application, you can choose the optimum performance level of an S-parameter analyzer (Option 122) or transmission reflection analyzer (base model).

You also can simultaneously measure and view all four S-parameters, with a single connection.

FieldFox VNA contains four independent, sensitive receivers. The receivers provide more than 100 dB of dynamic range for vector measurements of high rejection, narrowband devices such as RF filters. The receivers also make possible full 2-port error correction with the Unknown Thru method, allowing you to measure non-insertable devices.

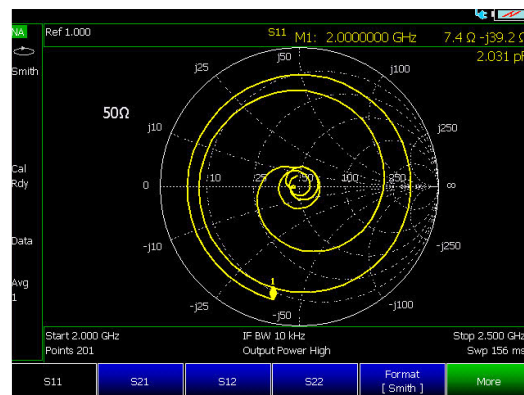
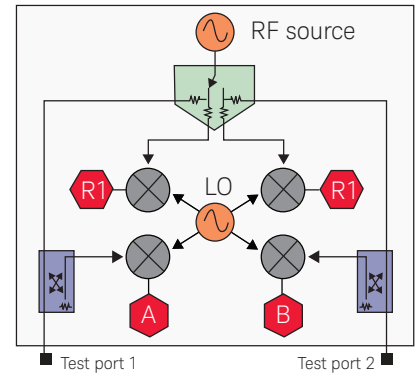

Smith chart display

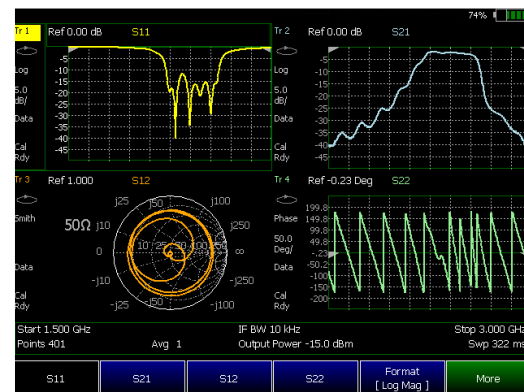

Make multiple measurements simultaneously



## Key Measurements (continued)

### Cable and antenna analyzer

Fifty to sixty percent of cell site problems are caused by faulty cables, connectors, and antennas. Degraded feed lines cause poor coverage, unnecessary handovers, paging failures and access failures on the uplink. To avoid service quality problems, it is critical to keep the cell sites' cable and antenna systems in good condition.

Use FieldFox to make return loss, VSWR, insertion loss/transmission, one-port cable loss, and distance-to-fault (DTF) measurements. You can test antennas, cables, filters, and amplifiers with a single handheld instrument.

### Return loss and DTF measurements

FieldFox can make return loss and distance-to-fault measurements at the same time. It helps you correlate overall system degradation with specific faults in the cable and antenna system.

The built-in cable editor allows you to edit existing cable types on-site, and save them as new cable types with user defined names.

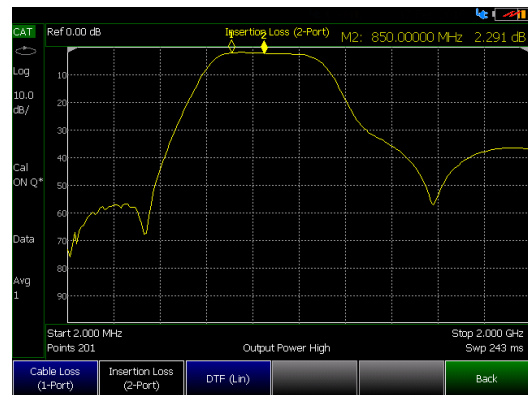

Insertion loss display

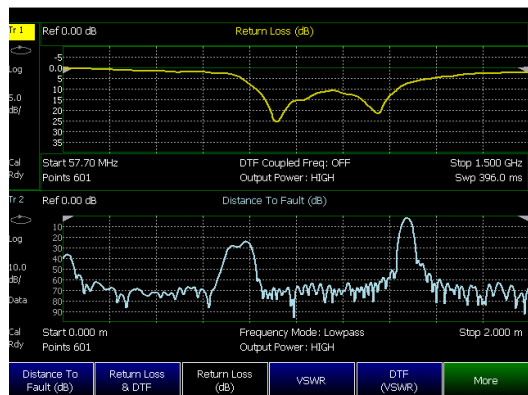

View and control the return loss and DTF displays independently



## CalReady when the instrument is turned on

Save time and get right to work with FieldFox's CalReady feature, which makes the unit calibration ready at either test port immediately following power on or preset. FieldFox is already calibrated and ready to make measurements such as S11, S22, 1-port cable loss, VSWR, return loss, and DTF measurements at the test port without having to connect/disconnect additional cables or calibration devices.

## Industry's first and only QuickCal

FieldFox is the industry's first and only handheld network analyzer with a built-in calibration capability that allows you to calibrate the network analyzer without carrying a calibration kit into the field. As with any test instrument, when you add an additional device to the test port, such as a jumper cable or adapter, you need to recalibrate using a calibration kit (cal kit). *QuickCal* eliminates the need to carry and use a cal kit, and also provides worry-free accuracy and excellent reliability. *QuickCal* allows the operator to easily correct drift errors caused by temperature changes during instrument operation.

The FieldFox RF VNA's full 2-port *QuickCal* supports measurements such as transmission/reflection, S21, S12, S11, S22, 1-port cable loss, VSWR, return loss, DTF, and gain/insertion loss. Full 2-port *QuickCal* is based on Keysight's Unknown Thru calibration methodology, providing an accurate way to measure a non-insertable device, such as a female-female filter.

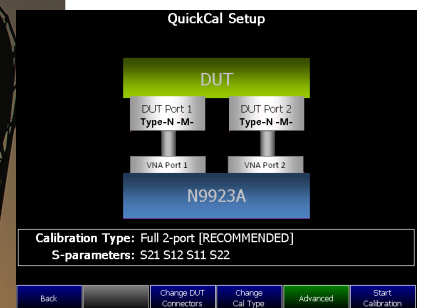
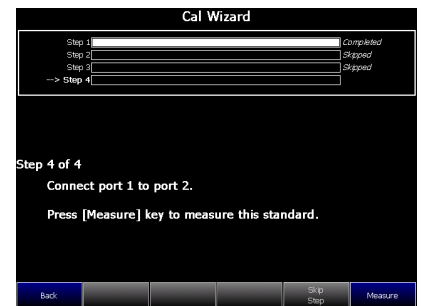
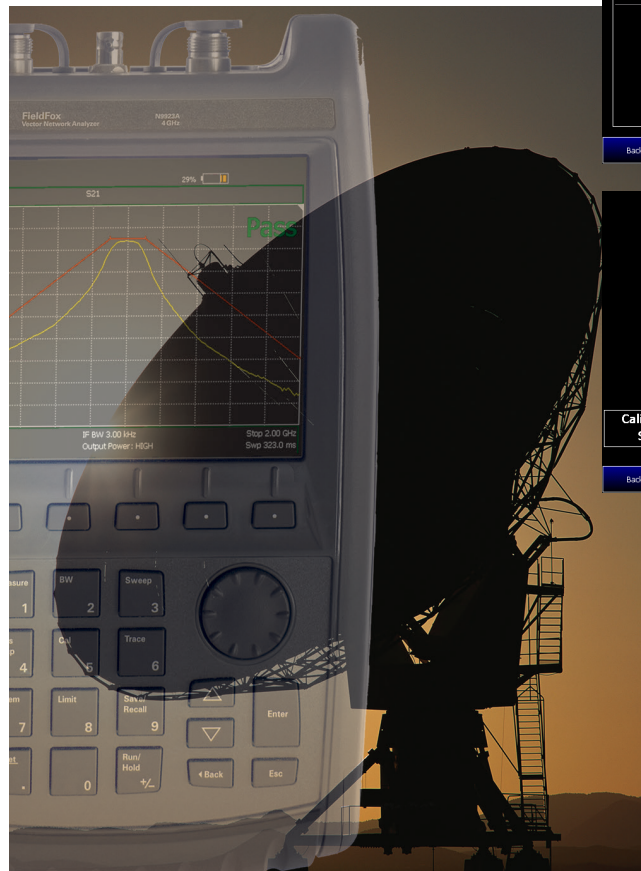

Calibration Wizard

## Broadband calibration

FieldFox allows you to make broadband calibrations, which means the instrument is calibrated over the maximum frequency range. After a broadband calibration, you can change the frequency range or number of points without recalibrating the instrument. The calibration is interpolated, and accuracy is maintained.

## User calibration kit support

FieldFox supports many Keysight standard calibration kits. In addition to *CalReady* and *QuickCal*, FieldFox also provides a comprehensive calibration utility. To obtain the most accurate measurement, users need to use cal kits that match their device connector types. FieldFox allows users to define their own mechanical calibration kits.

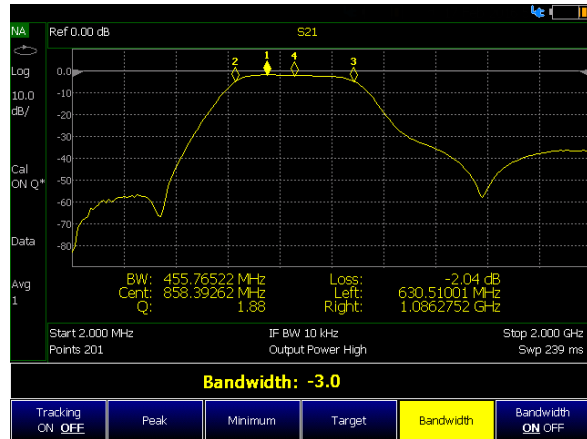

The marker bandwidth/Q factor function simplifies filter testing and tuning.

## Electrical delay and port extension

For in-fixture measurements, use FieldFox's port extension or electrical delay capability to easily extend the reference plane to the device interface for accurate measurements. You can use the electrical delay capability to measure *deviation from linear phase* by removing the linear portion of the phase delay.

## Power meter

FieldFox can connect with the Keysight USB power sensors to make average power measurements up to 40 GHz. Using USB peak power sensors, users can measure both the average and the peak power of a modulated signal.



Power meter display

## Pulse measurements

FieldFox's pulse measurement option allows users to efficiently characterize pulsed-RF signals such as those used in radar and electronic warfare systems, leveraging Keysight's USB peak power sensors (available in 18 and 40 GHz models). Measurements include peak power, peak to average ratio, and pulse profiling.

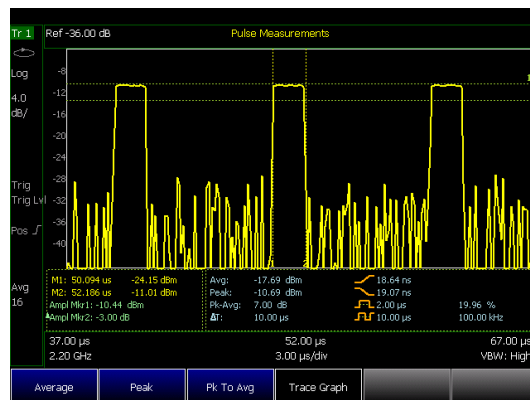

Pulse measurement display

## Time domain

With the time domain option, FieldFox computes the inverse Fourier transform of the frequency-domain data to display reflection or transmission coefficients versus time. Time domain gating can be used to remove unwanted responses such as connector mismatch or cable discontinuities, and the results can be displayed in either time or frequency domain. FieldFox's time domain function supports both low pass mode and band pass mode, enabling users to measure both broadband and frequency-selective devices.

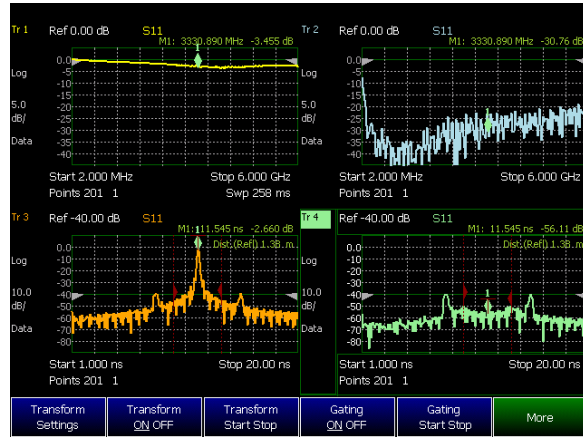

Use time domain gating to remove unwanted responses. Before gating: Traces 1 and 3, After gating: Traces 2 and 4.

## Vector voltmeter

Using FieldFox's vector voltmeter (VVM), the phase shift and electrical length of a device can be measured. By utilizing the "zero" function, the phase and electrical length of one device can be measured relative to a "golden device". You can view results on the large display.

The VVM option also provides ratio measurements of two receivers or two channels, A/B or B/A. An external signal source is required for this measurement. You can use this capability to verify the magnitude and phase differences between multiple signal paths.

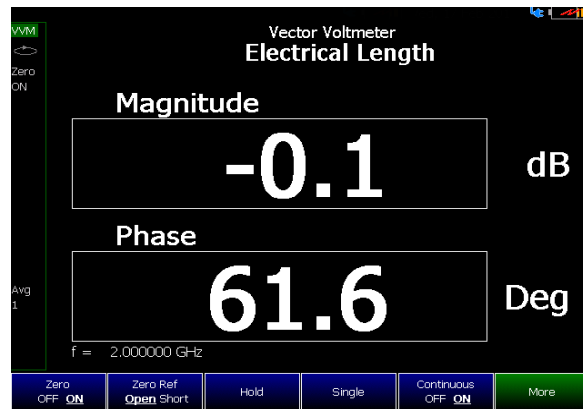

VVM applications:

- Cable trimming of phase matched cables
- Verifying the isolation of 2-port components

## 75 ohm device test

Most of the components used in cable TV systems are 75 ohm, like cables, filters, splitters and switches.

You can use the FieldFox RF VNA to measure 75-ohm devices easily. *QuickCal*, combined with a 50/75 ohm adapter (eg. Keysight part: N9910X-846) at each port and a 75 ohm load, turns the instrument into a 75 ohm tester. Alternatively you can use any of Keysight's 75 ohm calibration kits, along with a pair of 50/75 ohm adapters.

## Mixed- mode S-parameters

Using FieldFox's mixed-mode S-parameters, common and differential-mode reflections of a device can be measured. Mixed-mode S-parameters are also known as balanced measurements. This measurement requires the full 2-port VNA and 2-port cal functionality.

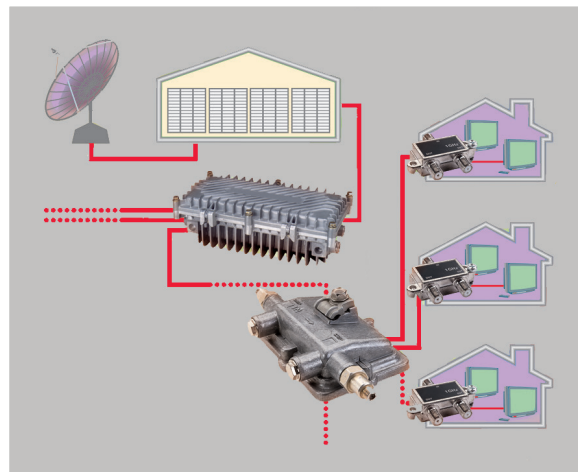

Cable TV distribution system, cable TV is a 75 ohm system



## Feature and Benefit Summary

Comprehensive measurement capabilities	
Vector network analysis	Provides accurate network analysis of RF components and enables you to measure and display all four S-parameters simultaneously, with a single connection. This means you can quickly and accurately characterize the device under test, using a handheld instrument.
Cable and antenna test <ul style="list-style-type: none"> <li>- Return loss, SWR</li> <li>- Distance-to-fault</li> </ul>	<p>Return loss/SWR measurements allow you to evaluate the impedance matching performance of a feed line across the frequency range of interest.</p> <p>Distance-to-fault measurements help you identify faults along a feed line. You can use these measurements to precisely pinpoint the location of damaged or degraded antennas, connectors, amplifiers, filters, duplexers, or other components.</p> <p>FieldFox provides up to a 1001 data-point resolution to help accurately locate faults and extend measurement distance.</p>
Transmission test <ul style="list-style-type: none"> <li>- Cable loss</li> <li>- Insertion loss</li> <li>- Amplifier gain</li> </ul>	Transmission tests are used to accurately measure cable loss, insertion loss (filters) and amplifier gain (tower mounted amplifier). FieldFox offers 2-port transmission magnitude and phase measurements with a typical dynamic range of 100 dB.
One-port cable loss	For already-installed cables, FieldFox accurately measures one-port cable loss. The instrument measures the actual cable loss, without the need for additional computations.
CalReady at test port	Each instrument is calibrated at the test ports. When you power up the instrument, it is ready to make measurements such as S11, S22, one-port cable loss, VSWR, return loss and DTF at the test port.
QuickCal	<p>The industry's first and only built-in calibration system allows you to calibrate the network analyzer without carrying a calibration kit into the field. QuickCal eliminates the hassle of carrying and using a cal kit, plus provides worry-free accuracy and excellent reliability.</p> <p>QuickCal allows operators to easily correct for drift errors caused by temperature changes during instrument operation. Full 2-port QuickCal is based on Keysight's Unknown Thru calibration methodology. It is an accurate way to measure non insertable devices, such as female-female duplexers.</p>
Mechanical calibration	Open-short-load (OSL) calibration is standard in FieldFox. Common calibration kit constants are preloaded in the instrument. Additional kits can be added by users.
Time domain	Using the time domain feature, you can display reflection or transmission coefficients versus time. Time domain gating can be used to remove unwanted responses such as connector mismatch or cable discontinuities.



Perform and view return loss and distance-to-fault measurements at the same time

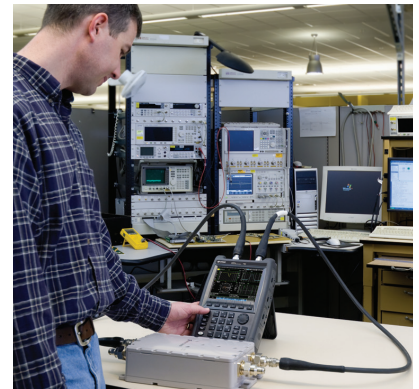

Tower mounted amplifier (TMA) measurement

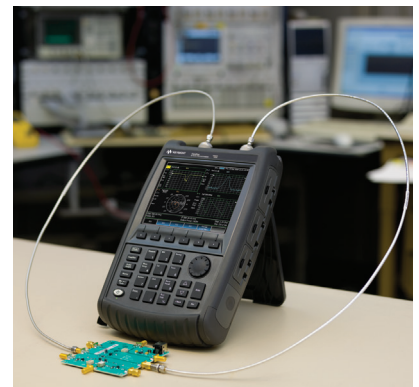

Filter and amplifier measurement

## Feature and Benefit Summary (continued)

Comprehensive measurement capabilities (continued)	
Interference rejection	The FieldFox RF VNA interference rejection mode is able to make reliable return loss and distance-to-fault measurements of cable and antenna systems under high interference signal environments. It can make valid measurements for interference signals coupled into the system up to +16 dBm.
Power meter	Makes accurate true average power measurements without the need for a power meter. The state-of-the-art Keysight USB power sensors provide measurements up to 24 GHz.
Smith chart	Smith charts can be used to display impedance matching characteristics in cable and antenna systems.
Vector voltmeter	The large vector voltmeter display makes it easy to match two or more device's electric length and ensure signals that travel on different devices have the same delay.
Electrical delay	Using the electrical delay function, you can remove the linear portion of the phase shift and view the deviation from linear phase.
Port extension	Allows you to extend the reference plane after calibration. This feature is useful for measurements such as in-fixture test, where calibrating at the DUT or reference plane is cumbersome.
GPS	Enables operators to find exact locations, and time/location stamp their measurement reports. The GPS information can be displayed on the screen, and saved as part of the image or data file, for reporting purposes.
Data management	
Limit lines	Automated pass/fail testing eliminates the guesswork from your test processes and helps ensure that your components are aligned and tested to the same specifications at all test stations. Pass/fail testing is easily accomplished with user-defined limit lines, which let you quickly and consistently compare measured data to test limits. The pass/fail results are displayed clearly on the instrument screen to minimize operator errors or misinterpretation.
Save/recall states	Save time and reduce operator errors with recall states. You can quickly switch between different manufacturing tests simply by recalling the appropriate instrument state. Saving and recalling states also eliminates operator errors that occur during repeated entry of instrument parameters. Each recall state contains all instrument parameters such as start and stop frequencies, power level, number of trace points, IF bandwidth, calibration data, markers, limit lines, and more.
Powerful marker functions	Speed up component test times by using the power of built-in data markers. Use the six markers per trace to display data in absolute or relative terms.

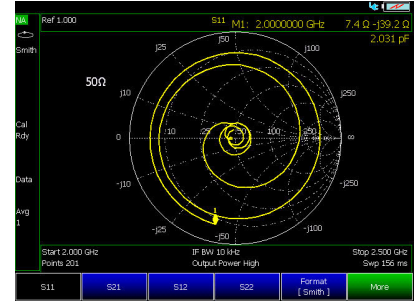

Smith chart display



Easy-to-use save/recall functions



Duplexer measurement

## Feature and Benefit Summary (continued)

Field-proof usability	
Transflective display and backlit keys	The display is designed for easy viewing in indoor and outdoor settings and in direct sunlight and darkness. Access different display modes via softkeys.
Functional key access	Front-panel keys make it easy to perform tasks and make measurements.
One-button measurement	Provides task-driven user interface to simplify the measurements.
Rugged design	
Water-resistant chassis, keypad and case design	The case is made from polycarbonates that withstand wide temperature ranges and salty, humid environments.
RF connector protection	A specially designed connector bay protects the RF connectors from damage during drops or other external impacts.
Dust-free design	With no vents or fans in the case, FieldFox resists dust for better equipment reliability.
Meets tough environmental standard	Industry's only handheld network analyzer with MIL Class 2 compliance with no exceptions.
Gasketed ports	Protects instrument from moisture.
Modern connectivity	
USB 2.0 ports	Two USB 2.0 ports can be used to transfer files.
LAN port	Used for data transfer, SCPI programming, Data Link connection, GPS receiver, and remote control via iOS device.
SCPI support <sup>1</sup>	SCPI over LAN and mini USB allows users to automate tests or control a FieldFox from a remote location.
Micro SD flash card slot	Use as a data storage device.
FieldFox Data Link software	Transfer data from the instrument to a PC for back-office applications such as baseline analysis and report generation.
Remote control capability	Remotely monitor and control FieldFox using an iOS device such as iPad or iPhone, via a LAN network connection.

1. SCPI over USB is only available for N9923A with serial number prefix starting with MY5607/SG5607/US5607 and N9923A upgraded with Option N9910HU-500.



Make accurate true average power measurements without bringing along a power meter



Transflective display makes it easy to read measurements in direct sunlight



Water resistant chassis withstands wide temperature ranges and humid environments



## Specifications

A condensed version of the specifications is provided here. See the User's Guide for the complete version; <http://literature.cdn.keysight.com/litweb/pdf/N9923-90001.pdf>

### Specification (spec.):

Warranted performance. Specifications include guardbands to account for the expected statistical performance distribution, measurement uncertainties, and changes in performance due to environmental conditions. The following conditions must be met:

- FieldFox has been turned on at least 10 minutes unless otherwise specified
- FieldFox is within its calibration cycle
- Storage or operation at 25 °C ±5 °C range (unless otherwise stated)

### Typical (typ.):

Expected performance of an average unit over a 20 °C to 30 °C temperature range, unless otherwise indicated; does not include guardbands. The FieldFox RF VNA must be within its calibration cycle.

### Nominal (nom.):

A general, descriptive term or design parameter.

## Specifications (continued)

### Network analysis

Measurements	
S11, S21	Magnitude and phase
S12, S22	Magnitude and phase (Option 122)
Display	Log, linear, phase, group delay, VSWR, Smith chart, polar chart, split screen to show different S-parameters and phases
System impedance selection	50 ohm and 75 ohm (with 50/75 ohm adapter)
Frequency	
Frequency range	Option 104: 2 MHz to 4 GHz Option 106: 2 MHz to 6 GHz
Frequency reference	Accuracy: $\pm 2$ ppm Aging rate: $\pm 1$ ppm Temperature stability: $\pm 1$ ppm over $-10$ to $55$ °C
Frequency resolution	1 Hz
Measurement speed (Sweep time) <sup>1</sup> S11 and S21, 2 MHz to 6 GHz 30 kHz IFBW, 1001 points	0.365 ms/point
Data points	101, 201, 401, 601, 801, 1001, 1601, 4001, 10,001 (custom number of points can be set using SCPI)
Directivity	Corrected: 42 dB
System dynamic range (S21)	2 MHz to 6 GHz: 100 dB (typical)
IF bandwidth	300 Hz, 1 kHz, 3 kHz, 10 kHz, and 30 kHz
Output power range	High power: +5 dBm (nominal) Low power: -40 dBm (nominal)
Trace noise (high output power, IF band)	Magnitude: < 0.01 dB rms width = 300 Hz)
Immunity to interference	+16 dBm (nominal)
Maximum input level port 1 or port 2	+23 dBm / $\pm 50$ VDC

1. 0.695 ms/point; applicable for N9923A with serial number prefix < than MY5607/SG5607/US5607 and N9923A not upgraded with Option N9910HU-500.

## Specifications (continued)

### Cable and antenna analyzer (Option 305)

Capabilities	
Return loss	
VSWR	
Distance-to-fault (DTF)	<ul style="list-style-type: none"> <li>- Range = <math>(n - 1)/(\text{span} * 2) \times V_f</math> (velocity factor in cable) x C (light speed)</li> <li>- Resolution = range/number of points</li> <li>- Number of points: 101, 201, 401, 601, 801, 1001</li> <li>- Distance-to-fault display: Return loss, VSWR , reflection coefficient</li> </ul>
Cable loss (1-port)	Terminated cable under test with short
Transmission measurement (insertion loss and gain)	
Calibration types	CalReady One port mechanical calibration Full 2-port mechanical calibration Enhanced response calibration <b>QuickCal</b> (1-port and 2-port) Automatic cal update with frequency change

### Vector network analyzer time domain (Option 010)

Using time domain, data from transmission or reflection measurements in the frequency domain are converted to the time domain. The time-domain response shows the measured parameter value versus time.

Time stimulus modes	
Low-pass step	This stimulus, similar to a traditional time domain reflectometer (TDR) stimulus waveform, is used to measure low-pass devices. The frequency-domain data should extend from DC (extrapolated value) to a higher value.
Low-pass impulse	This stimulus is also used to measure low-pass devices.
Bandpass impulse	The bandpass impulse stimulates a pulsed RF signal and is used to measure the time-domain response of band-limited devices.
Windows	
	The windowing function can be used to filter the frequency-domain data and thereby reduce overshoot and ringing in the time-domain response.
Gating	
	The gating function can be used to selectively remove reflection or transmission time-domain responses. In converting back to the frequency domain the effects of the responses outside the gate are removed.



## Specifications (continued)

### Power meter measurement (Option 302)

Support for Keysight USB average and peak power sensors. Frequency and power range dependent on sensor. List of supported sensors: <http://www.keysight.com/find/usbsensorsforfieldfox>

### Pulse measurements with USB peak power sensor (Option 330)

FieldFox's pulse measurement option can be used to characterize RF pulses such as those used in radar and electronic warfare systems. Measurements are made using FieldFox and Keysight's USB peak power sensors.

Performance specifications such as frequency, dynamic range and minimum pulse width depend on the peak power sensor. Supported peak power sensors: <http://www.keysight.com/find/usbsensorsforfieldfox>.

### Remote control capability with iPad or iPhone (Option 030)

Users can now remotely monitor and control their FieldFox using their iOS device such as an iPad, iPhone, or iPod Touch. FieldFox's Remote Viewer iOS app emulates the front panel of the unit, so users can simply press any FieldFox key right from their iOS device, including the hardkeys or softkeys.

With this technology, FieldFox can now be placed in areas where users do not wish to stay long due to extremely harsh or unsafe conditions. Additionally, if one technician or engineer has trouble making a measurement or determining the source of a problem, another can step in to remotely troubleshoot and solve the problem, which helps minimize rework and multiple trips.

When the application is launched, users can access the FieldFox demo videos and technical literature such as user guides, application notes, and datasheets. Accessing this information via the FieldFox app helps engineers and technicians in the field quickly find the data they need to resolve issues as they arise. Such capabilities also make the app ideal for training and educational purposes.

The iOS device and FieldFox communicate via a WLAN or broadband data connection. Without Option 030, users can remotely view the live display screen of their FieldFox, but *cannot control* the instrument.

## Specifications (continued)

General specifications	
Connector type (port 1 and port 2)	Type N female
Test port impedance	50 ohm
External reference	Input type: BNC female Reference frequency: 10 MHz Required level: -5 dBm to 10 dBm
External trigger input	Impedance: 10 k $\Omega$ Level range: Rise edge: 17V; falling edge: 1V
Display	6.5" transfective, color VGA LED backlit 640 x 480 with anti-glare coating
Speaker	Built-in speaker
Headphone jack	Built-in headphone jack
Connectivity	2 x USB 2.0; 1 x mini USB; 1 x LAN
GPS	Latitude, longitude, elevation, and accurate time are provided. The GPS information can be displayed on the screen and saved as part of the image or data file. The GPS capability is standard with all N9912A FieldFox RF analyzers. An external USB GPS receiver is required. Keysight recommends the Microsoft Streets & Trips, or Microsoft AutoRoute with GPS locator.
Internal storage	Minimum 4 GB, up to 1000 traces
External storage	1 x micro SD slot and 2 x USB 2.0
EMC	Complies with European EMC Directive 2004/108/EC <ul style="list-style-type: none"> <li>- IEC/EN 61326-1</li> <li>- CISPR Pub 11 Group 1, Class A</li> <li>- AS/NZS CISPR 11</li> <li>- ICES/NMB-001</li> </ul>
ESD	- IEC/EN 61000-4-2, functional up to 20 kV test
Safety	Complies with European Low Voltage Directive 2006/95/EC <ul style="list-style-type: none"> <li>- IEC/EN 61010-1 2nd Edition</li> <li>- Canada: CSA C22.2 No. 61010-1-04</li> <li>- USA: UL 61010-1 2nd Edition</li> </ul>
Environmental	Compliant with MIL-PRE-28800F Class 2 general requirements - no exceptions
Temperature	Operating: -10 °C to 55 °C Non operating: -51 °C to 71 °C
Weight	6 lbs / 2.7 kg including battery
Dimensions (H x W x D)	292 x 188 x 72 mm (11.5" x 7.4" x 2.8")
Power	Power supply: External DC input: 15 to 19 VDC
External AC power adapter	Input: 100 to 250 VAC, 50 to 60 Hz; 1.25 to 0.56 A Output: 15 VDC, 4 A Power consumption: 14 W (typical) Battery: 6 cell Lithium Ion, 10.8 V, 4.6 A-h Battery operating time: 3.5 hours
Language	English, Chinese, French, Spanish, Japanese, Russian, German, Italian, and Turkish

## Configuration Information

### N9923A FieldFox RF vector network analyzer options

Option 104	4 GHz RF vector network analyzer, transmission/reflection
Option 106	6 GHz RF vector network analyzer, transmission/reflection
Option 010	Cable and antenna analyzer QuickCal
Option 030	Remote control capability from iOS device
Option 112	USB power sensor measurements versus frequency
Option 122	Full 2-port S-parameters
Option 208	Time domain
Option 212	Mixed-mode S-parameters
Option 302	External USB power sensor support
Option 305	Cable and antenna analyzer
Option 308	Vector voltmeter
Option 330	Pulse measurements with USB peak power sensor
Standard accessories	AC/DC adapter; battery; soft carrying case; LAN cable, Quick Reference Guide, and full manual

For more information go to: [www.keysight.com/find/fieldfox](http://www.keysight.com/find/fieldfox)

### N9923A Upgrades

The following upgrades are available for the N9923A FieldFox RF handheld vector network analyzer. More information regarding upgrades is available at: [www.keysight.com/find/fieldfoxsupport](http://www.keysight.com/find/fieldfoxsupport)

Product number	Description	Additional requirements
N9923AU-010	Time domain analysis	None
N9923AU-030	Remove control capability	None
N9923AU-112	QuickCal	Option 212 for 2-port QuickCal
N9923AU-122	Full 2-port S-parameters	None
N9923AU-208	USB power sensor measurements versus frequency	Option 302
N9923AU-212	Mixed-mode S-parameters	Option 122
N9923AU-302	External USB power sensor support	None
N9923AU-305	Cable and antenna analyzer	None
N9923AU-308	Vector voltmeter	None
N9923AU-330	Pulse measurements	None

### N9923A Hardware Upgrade

Option <sup>1,2</sup>	Description	Upgrade contents	Additional requirements
N9910HU-500	N9912A/N9923A processor upgrade	Improved performance for N9912A and N9923A models	Return to service center only

1. Upgrades are not available for N9923A analyzer with serial number prefix starting with MY5607/SG5607/US5607, as this analyzer already has the improved hardware.
2. Please contact your local Keysight Service Center for instructions on how and where to send the instrument, and how to order the factory upgrades.

## Configuration Information (continued)

### N9910X RF/MW handheld analyzer accessories

N9910X-800	T-calibration kit, DC-6 GHz, Type-N (m)
N9910X-801	T-calibration kit, DC-6 GHz, Type-N (f)
N9910X-802	T-calibration kit, DC-6 GHz, 7/16 DIN (m)
N9910X-803	T-calibration kit, DC-6 GHz, 7/16 DIN (f)
85514A	4-in-1 OSLT mechanical calibration kit, DC to 9 GHz, Type-N (m), 50 ohm
85515A	4-in-1 OSLT mechanical calibration kit, DC to 9 GHz, Type-N (f), 50 ohm
N9910X-810	Rugged phase-stable cable, Type-N (m) to Type-N (m), 5 ft
N9910X-811	Rugged phase-stable cable, Type-N (m) to Type-N (f), 5 ft
N9910X-812	Rugged phase-stable cable, Type-N (m) to Type-N (m), 12 ft
N9910X-813	Rugged phase-stable cable, Type-N (m) to Type-N (f), 12 ft
N9910X-814	Rugged phase-stable cable, Type-N (m) to 7/16 (m), 60 inch or 1.5 m
N9910X-815	Rugged phase-stable cable, Type - N (m) to 7/16 (m), 12 ft or 3.6 m
N9910X-816	Rugged phase-stable cable, Type-N (m) to Type-N (f), 3.28 ft or 1 m
N9910X-817	Rugged phase-stable cable, Type-N (m) to Type-N (m), 3.28 ft or 1 m
N9910X-843	Coaxial adapter, Type-N (m) to 7/16 DIN (f)
N9910X-845	Adapter kit: Type-N (f) to 7/16 DIN (f), Type-N (f) to 7/16 DIN (m), Type-N (f) to Type-N (f)
N9910X-846	Coaxial adapter, Type-N (m) 50 ohm to Type-N (f) 75 ohm (recommend quantity 2 for 75 ohm measurements)
N9910X-860	Fixed attenuator, 40 dB, 100 W, DC-3 GHz, Type-N (m) to Type-N (f)
N9910X-861	Fixed attenuator, 40 dB, 50 W, DC-8.5 GHz, Type-N (m) to Type-N (f)
N9910X-870	Extra battery
N9910X-872	External battery charger
N9910X-873	AD/DC adapter
N9910X-874	External bias-tee, 2.5 MHz to 6 GHz, 1 W, 0.5 A
N9910X-880	Extra soft carrying case with backpack and shoulder strap
N9910X-875	DC car charger and adapter
N9910X-881	Hard transit case

For more information go to: [www.keysight.com/find/fieldfox](http://www.keysight.com/find/fieldfox)



## Accessories

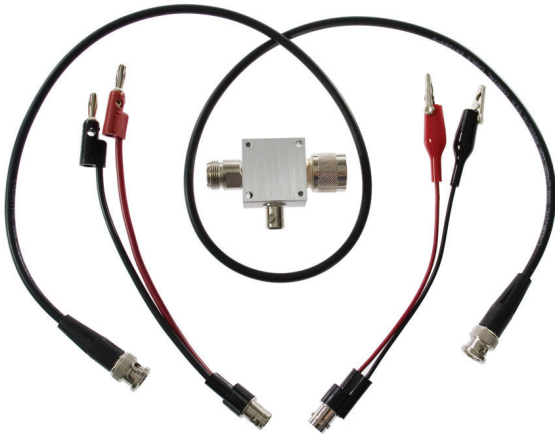

Bias-tee, N9910X-874



Phase stable cable, N9910X-810

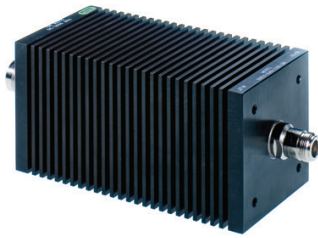

100 Watt attenuator, N9910X-860



Adapter kit, N9910X-845



85514A



85515A



N9910X-800



N9910X-801

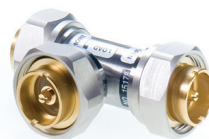

N9910X-802



N9910X-803

T-Cal kits

## Accessories (continued)



Soft carrying case with backpack and shoulder straps included with a standard N9912A. For an extra soft carrying case order N9910X-880



Hard transit case, N9910X-881

FieldFox fits inside hard transit case



AC/DC adapter, N9910X-873



External battery charger, N9910X-872

## Evolving Since 1939

Our unique combination of hardware, software, services, and people can help you reach your next breakthrough. We are unlocking the future of technology.  
 From Hewlett-Packard to Agilent to Keysight.

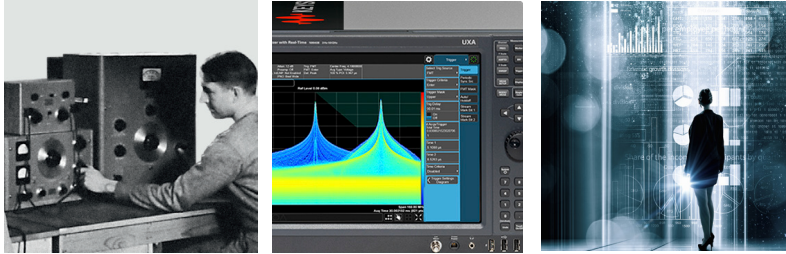

For more information on Keysight Technologies' products, applications or services, please contact your local Keysight office. The complete list is available at: [www.keysight.com/find/contactus](http://www.keysight.com/find/contactus)

### Americas

Canada	(877) 894 4414
Brazil	55 11 3351 7010
Mexico	001 800 254 2440
United States	(800) 829 4444

### Asia Pacific

Australia	1 800 629 485
China	800 810 0189
Hong Kong	800 938 693
India	1 800 11 2626
Japan	0120 (421) 345
Korea	080 769 0800
Malaysia	1 800 888 848
Singapore	1 800 375 8100
Taiwan	0800 047 866
Other AP Countries	(65) 6375 8100

### Europe & Middle East

Austria	0800 001122
Belgium	0800 58580
Finland	0800 523252
France	0805 980333
Germany	0800 6270999
Ireland	1800 832700
Israel	1 809 343051
Italy	800 599100
Luxembourg	+32 800 58580
Netherlands	0800 0233200
Russia	8800 5009286
Spain	800 000154
Sweden	0200 882255
Switzerland	0800 805353
	Opt. 1 (DE)
	Opt. 2 (FR)
	Opt. 3 (IT)
United Kingdom	0800 0260637

For other unlisted countries:  
[www.keysight.com/find/contactus](http://www.keysight.com/find/contactus)  
 (BP-9-7-17)



[www.keysight.com/go/quality](http://www.keysight.com/go/quality)  
 Keysight Technologies, Inc.  
 DEKRA Certified ISO 9001:2015  
 Quality Management System

### myKeysight

#### myKeysight

[www.keysight.com/find/mykeysight](http://www.keysight.com/find/mykeysight)

A personalized view into the information most relevant to you.

[www.keysight.com/find/emt\\_product\\_registration](http://www.keysight.com/find/emt_product_registration)

Register your products to get up-to-date product information and find warranty information.

### KEYSIGHT SERVICES

*Accelerate Technology Adoption.  
 Lower costs.*

#### Keysight Services

[www.keysight.com/find/service](http://www.keysight.com/find/service)

Keysight Services can help from acquisition to renewal across your instrument's lifecycle. Our comprehensive service offerings—one-stop calibration, repair, asset management, technology refresh, consulting, training and more—helps you improve product quality and lower costs.



#### Keysight Assurance Plans

[www.keysight.com/find/AssurancePlans](http://www.keysight.com/find/AssurancePlans)

Up to ten years of protection and no budgetary surprises to ensure your instruments are operating to specification, so you can rely on accurate measurements.

#### Keysight Channel Partners

[www.keysight.com/find/channelpartners](http://www.keysight.com/find/channelpartners)

Get the best of both worlds: Keysight's measurement expertise and product breadth, combined with channel partner convenience.

[www.keysight.com/find/fieldfox](http://www.keysight.com/find/fieldfox)