

Keysight Technologies

L-Series Multiport Electromechanical Coaxial Switches

L7104A/B/C and L7106A/B/C Terminated

L7204A/B/C and L7206A/B/C Unterminated

DC to 4 GHz, DC to 20 GHz, DC to 26.5 GHz

Technical Overview



Product Overview

In today's competitive world, automated test systems demand higher accuracy and performance than ever before. The Keysight Technologies, Inc. L Series L7104A/B/C and L7106A/B/C terminated and L7204A/B/C and L7206A/B/C unterminated, multiport switches offer the improvements in insertion loss repeatability and isolation necessary to achieve higher test system performance. Long life, repeatability, and reliability lower the cost of ownership by reducing calibration cycles and increasing test system uptime and are vital to ATS measurement system integrity over time.

Description

The L7104/L7204A,B,C SP4T and L7106/L7206A,B,C SP6T multiport switches provide the life and reliability required for automated test and measurement, signal monitoring, and routing applications. Innovative design and careful process control creates switches that meet the requirements for highly repeatable switching elements in test instruments and switching interfaces. The exceptional 0.03 dB insertion loss repeatability is warranted for 2 million cycles at 25 °C. This reduces sources of random errors in the measurement path and improves measurement uncertainty. Switch life is a critical consideration in production test systems, satellite and antenna monitoring systems, and test instrumentation. The longevity of these switches increases system uptime, and lowers the cost of ownership by reducing calibration cycles and switch maintenance.

High-performance multiport switches at an affordable price

- 0.03 dB repeatability ensures accuracy and reduces calibration cycles for the entire 2 million cycle operating life.
- Operating life of 5 million cycles typical
- Unmatched isolation maximizes measurement accuracy and improves system dynamic range
- Economical price minimizes budgetary constraints

High-performance multiport switches for microwave and RF instrumentation and systems

- SP4T and SP6T configuration
- Magnetic latching
- 0.03 dB insertion loss repeatability for 2 million cycles
- Excellent isolation, typically > 85 dB at 26.5 GHz
- Opto-electronic indicators and interrupts
- Terminated and unterminated ports
- TTL/5 V CMOS compatible (optional)

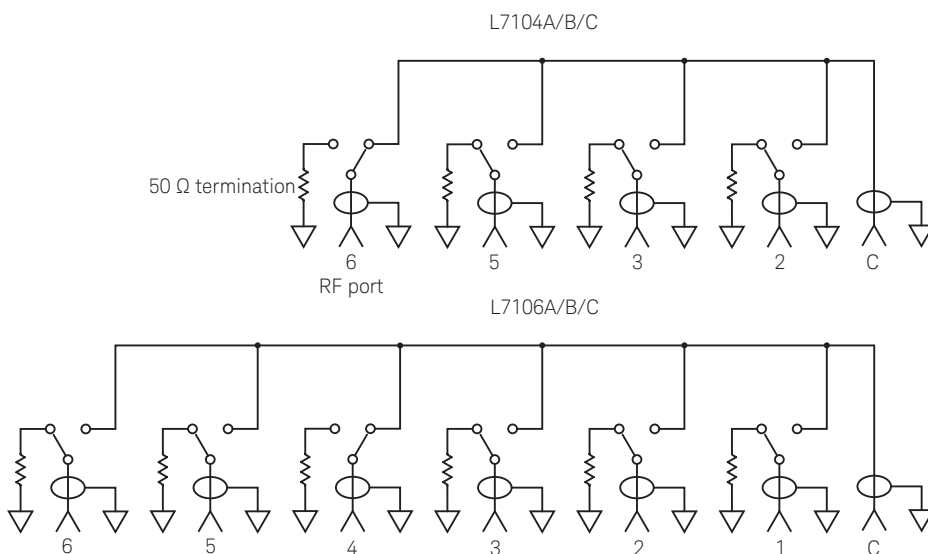

Figure 1. Keysight L7104A/B/C and L7106A/B/C simplified schematics

Product Overview (continued)

Operating up to 4 GHz (A models), 20 GHz (B models), and 26.5 GHz (C models), these switches exhibit the exceptional isolation performance required to maintain measurement integrity. Isolation between ports is typically > 90 dB to 12 GHz and > 85 dB to 26.5 GHz. This reduces the influence of signals from other channels, sustains the integrity of the measured signal, and reduces system measurement uncertainties. These switches also minimize measurement uncertainty with low insertion loss and reflection, which make them ideal elements in large multitiered switching systems.

All the L7104/L7204A,B,C and L7106/L7206A,B,C are designed to fall within most popular industry footprints. The 2¼ inch square flange provides mounting holes, while the rest of the 2½ inch long by 2¼ inch diameter body will easily fit into most systems. Ribbon cable or optional solder terminal connections accommodate the need for secure and efficient control cable attachment.

Option 100 provides solder terminal connections in place of the 16-pin ribbon drive cable. Option 100 does not incorporate the “open all paths” feature.

Opto-electronic interrupts and indicators improve reliability and extend the life of the switch by eliminating DC circuit contact failures characteristic of conventional electromechanical switches. These switches have an interrupt circuit that provides logic to open all but the selected ports, it then closes the selected ports cutting off the current to the solenoids of the ports. These switches also offer independent indicators that are controlled by optical interrupts in the switch. The indicators provide a closed path between the indicator common pin and the corresponding sense pin of the selected path.

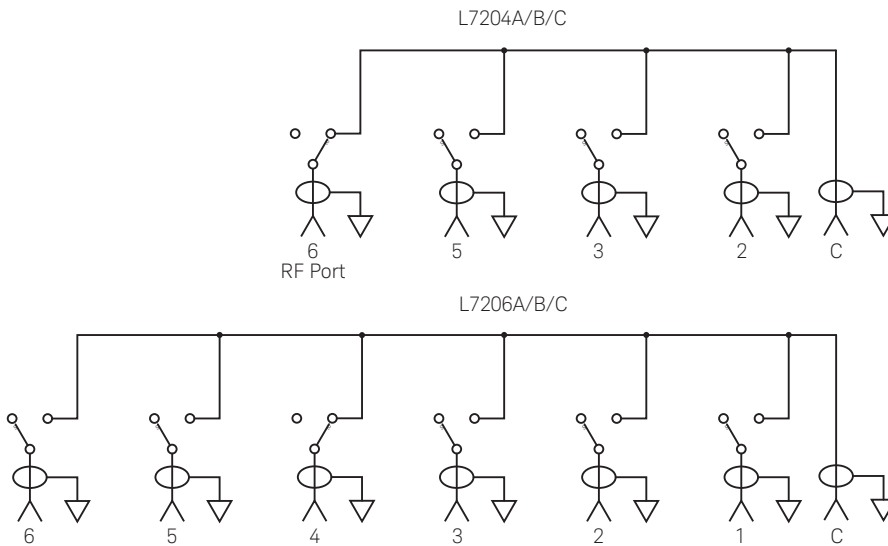

Figure 2. Keysight L7204A/B/C and L7206A/B/C unterminated simplified schematics

Applications

Multiport switches find use in a large number of applications, increasing system flexibility and simplifying system design.

Signal routing

The simplest signal routing scheme takes the form of single input to multiple outputs. These matrixes are often used on the front of an analyzer to test several two-port devices sequentially or to test multiport devices. In surveillance applications, a multiport switch can be used to select the optimum antenna for intercepting a signal. Two methods can be used to accomplish the single input to multiple output arrangement. Traditionally where isolation greater than 60 dB was required, a tree matrix composed of SPDT switches was used. While this gave great isolation, it was at the cost of more switches (Figure 3). These switches have port-to-port isolations typically greater than 85 dB at 26.5 GHz, eliminating the need to use a tree matrix in order to achieve high isolation (Figure 4). In addition to the reduced part count, the path lengths are shorter, so insertion loss is less, and paths are of equal length, so phase shift is constant.

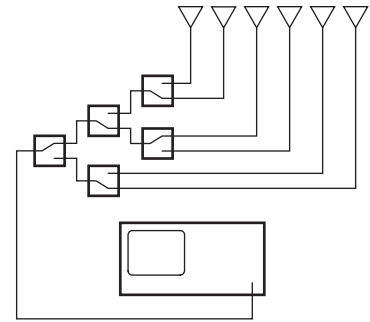

Figure 3. Tree matrix

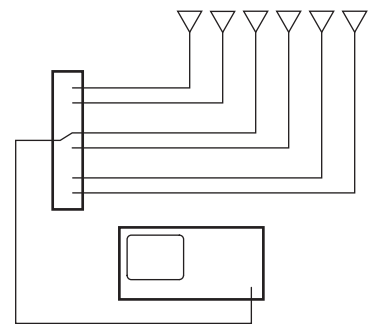

Figure 4. Multiport matrix

Full access switching

Full access switching systems give the flexibility to route multiple input signals to multiple outputs simultaneously. Full access switching matrixes are used in generic test systems in order to provide flexible routing of signals to and from many different devices under test, and stimulus and analysis instrumentation. Cross-point matrixes, using single pole double throw and cross-point switches, have traditionally been used in order to maintain high channel-to-channel isolation (Figure 5). As with the tree matrixes, this is at the cost of hardware and performance. Full access switching can also be achieved using multiport switches (Figure 6).

The advantage of the multiport matrix over the cross-point matrix is lower insertion loss and improved SWR performance due to consistent path length and fewer switches and connecting cables.

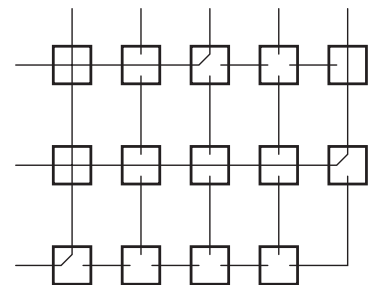

Figure 5. Cross-point matrix

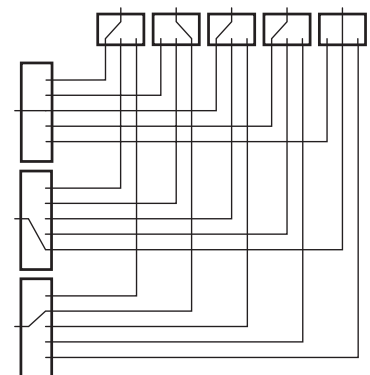

Figure 6. Full access matrix

Applications

Dedicated switching

There are a number of applications where switching is used, not for flexibility, but to accomplish a particular function within an instrument. For example, switched filter banks for reducing harmonics in the output of sources or to the input of analyzers can use multipoint switches in series to select the right filter for the band of interest. For larger switching systems, where many switches are used to provide complex signal routing, a switch driver such as the Keysight 11713B/C with L7104/6 or L7204/6 switches is recommended.

Driving the switch

Each RF path can be closed by applying ground (TTL “High” for Option T24) to the corresponding “drive” pin. In general, all other RF paths are simultaneously opened by internal logic.

Standard drive (Option 024)

See Figure 11 for drive connection diagrams.

- Connect pin 1 to supply (+20 VDC to +32 VDC)
- Connect pin 15 to ground (see Note 1).
- Select (close) desired RF path by applying ground to the corresponding “drive” pin; for example ground pin 3 to close RF path 1 (see Note 2).
- To select another RF path, ensure that all unwanted RF path “drive” pins are disconnected from ground (to prevent multiple RF path engagement). Ground the “drive” pin which corresponds to the desired RF path (see Note 3).
- To open all RF paths, ensure that all RF path “drive” pins are disconnected from ground. Then, connect pin 16 to ground. This feature is not available with Option 100.

TTL drive (Option T24)

See Figures 15 and 16 for drive connection diagrams.

- Connect pin 1 to supply (+20 VDC to +32 VDC)
- Connect pin 15 to ground (see Notes 1, 4).
- Select (close) desired RF path by applying TTL “High” to the corresponding “drive” pin; for example apply TTL “High” to pin 3 to close RF path 1 (see Note 2).
- To select another path, ensure that all unwanted RF path “drive” pins are at TTL “Low” (to prevent multiple RF path engagement). Apply TTL “High” to the “drive” pin which corresponds to the desired RF path (see Note 3).
- To open all RF paths, ensure that all RF path “drive” pins are at TTL “Low.” Then, apply TTL “High” to pin 16. This feature is not available with Option 100.

Notes:

1. Pin 15 must always be connected to ground to enable the electronic position-indicating circuitry and drive logic circuitry. **CAUTION: IF PIN 15 IS NOT CONNECTED TO POWER SUPPLY GROUND, CATASTROPHIC FAILURE WILL OCCUR.**
2. After the RF path is switched and latched, the drive current is interrupted by the electronic position-sensing circuitry. Pulsed control is not necessary, but if implemented, the pulse width must be 15 ms minimum to ensure that the switch is fully latched.
3. The default operation of the switch is break-before-make. Make-before-break switching can be accomplished by simultaneously selecting the old RF path “drive” pin and the new RF path “drive” pin. This will simultaneously close the old RF path and the new RF path. Once the new RF path is closed (15 ms), de-select the old RF path “drive” pin while leaving the new RF path “drive” pin selected. The switch circuitry will automatically open the old RF path while leaving the new RF path engaged.
4. In addition to the quiescent current supplying the electronic position-sensing circuitry, the drive current flows out of pin 15 (during switching) on TTL drive switches (Option T24).

Applications

Electronic position indicators

The electronic position indicators consist of optically isolated, solid-state relays which are driven by photo-electric sensors coupled to the mechanical position of the RF path's moving elements (Figure 7). The circuitry consists of a common which can be connected to an output corresponding to each RF path. If multiple RF paths are engaged, the position indicator corresponding to each closed RF path will be connected to common. The solid state relays are configured for AC and/or DC operation. (See indicator specifications on page 8.) The electronic position indicators require that the supply (20 to 32 VDC) be connected to pin 1 and ground connected to pin 15.

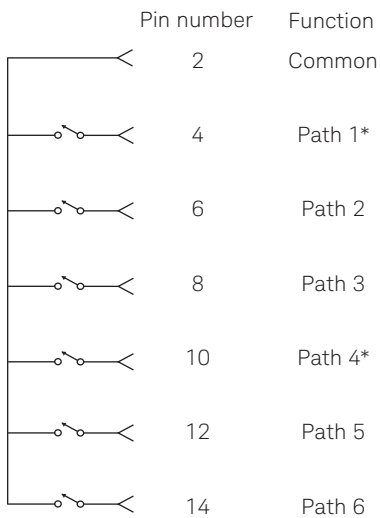

* Paths 1 and 4 are not connected for the L7104A/B/C and L7204A/B/C

Figure 7. Pin function diagram

Specifications

Specifications describe the instrument's warranted performance. Supplemental and typical characteristics are intended to provide information useful in applying the instrument by giving typical, but not warranted performance parameters.

Life	2,000,000 cycles minimum
Switching time	15 ms maximum
Maximum power rating Into internal termination	1 W CW 50 W peak, 10 μ s max pulse width, not to exceed 1 W average
Into thru path Hot switching	2 W CW 100 W peak, 10 μ s max pulse width, not to exceed 2 W average

Supplement specifications (Cold switching):

- Cold switching only (NO Hot switching)
- Ambient temperature of 75 °C or less
- Sea level (0.88 derating at 15,000 ft.)
- Load VSWR < 1.2 (see graph for derating above 1.2 VSWR)

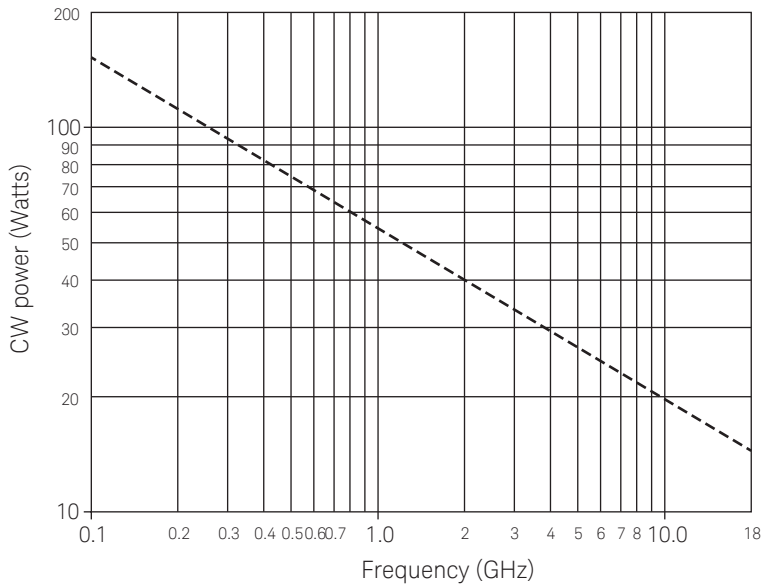

Figure 8. Power rating for cold switching at 75 °C

Specifications

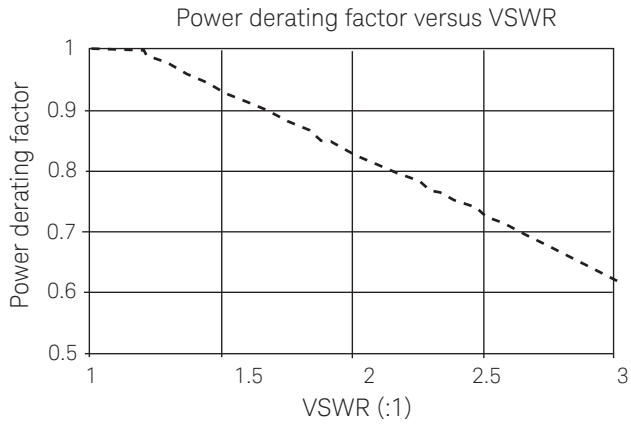

Figure 9. Power derating factor versus VSWR

Indicator specifications

Maximum withstand voltage	60 V
Maximum current capacity	150 mA
Maximum “ON” resistance	2.5 Ω
Maximum “OFF” resistance	10 G Ω

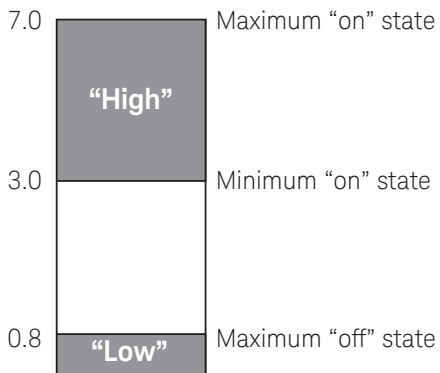

Figure 10. TTL control voltage states (Option T24)

Specifications

Switch drive specifications

Parameter test	Conditions	Min	Nom	Max	Units
Supply voltage, V_{cc}					
Option 024 and T24		20	24	32	V
Supply current, I_{cc}					
	Switching pulse width ≥ 15 ms: $V_{cc} = 24$ VDC ¹				
Option 024 and T24			200 ¹		mA
Supply current (quiescent)					
Option 024 and T24		25		50	mA
Option T24					
High level input		3		7	V
Low level input				0.8	V
Max high input current	$V_{cc} = \text{Max}$ $V_{input} = 3.85$ VDC		1	1.4	mA

1. Closing one RF path requires 200 mA. Add 200 mA for each additional RF path closed or opened.
Using all RF paths open (selecting pin 16) requires 200 mA per RF path reset with $V_{cc}=24$ VDC.

	L7104A/L7204A L7106A/L7206A	L7104B/L7204B L7106B/L7206B	L7104C/L7204C L7106C/L7206C
Frequency range	DC to 4 GHz	DC to 20 GHz	DC to 26.5 GHz
Insertion loss (see Figure 11)	0.3 dB + 0.015 x frequency (GHz)	0.3 dB + 0.015 x frequency (GHz)	0.3 dB + 0.015 x frequency (GHz)
Isolation (see Figure 12)	90 dB minimum	90 dB minimum, DC to 12 GHz 70 dB minimum, 12 to 15 GHz 65 dB minimum, 15 to 20 GHz	90 dB minimum, DC to 12 GHz 70 dB minimum, 12 to 15 GHz 65 dB minimum, 15 to 20 GHz 60 dB minimum, 20 to 26.5 GHz
SWR	1.2 maximum	1.2 maximum, DC to 4 GHz 1.35 maximum, 4 to 12.4 GHz 1.45 maximum, 12.4 to 18 GHz 1.7 maximum, 18 to 20 GHz	1.2 maximum, DC to 4 GHz 1.35 maximum, 4 to 12.4 GHz 1.45 maximum, 12.4 to 18 GHz 1.7 maximum, 18 to 26.5 GHz
Repeatability (Up to 2 million cycles measured at 25 °C)	0.03 dB maximum	0.03 dB maximum	0.03 dB maximum
Connectors	SMA (f)	SMA (f)	SMA (f)

Specifications

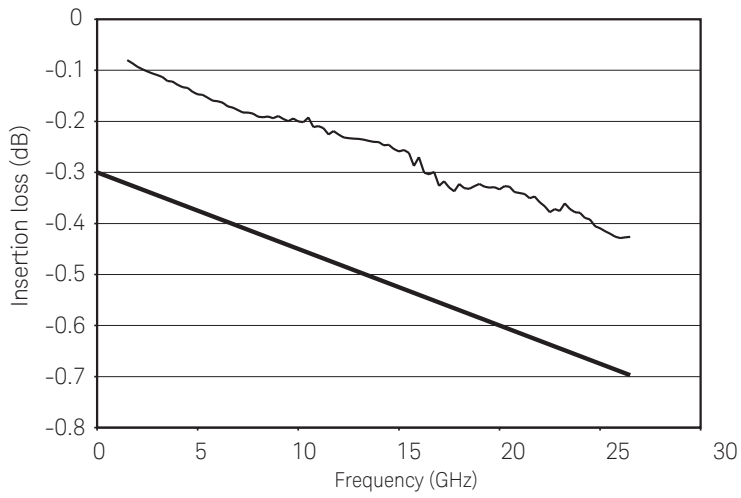

Figure 11. Keysight L-Series multiport switch insertion loss versus frequency

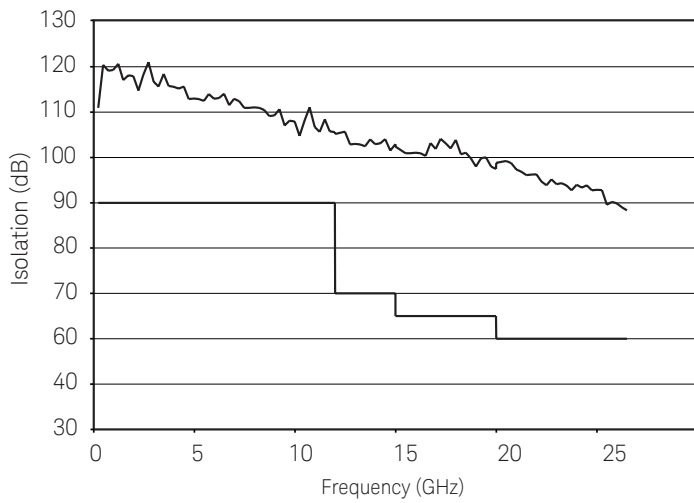

Figure 12. Keysight L-Series multiport switch isolation versus frequency

Specifications

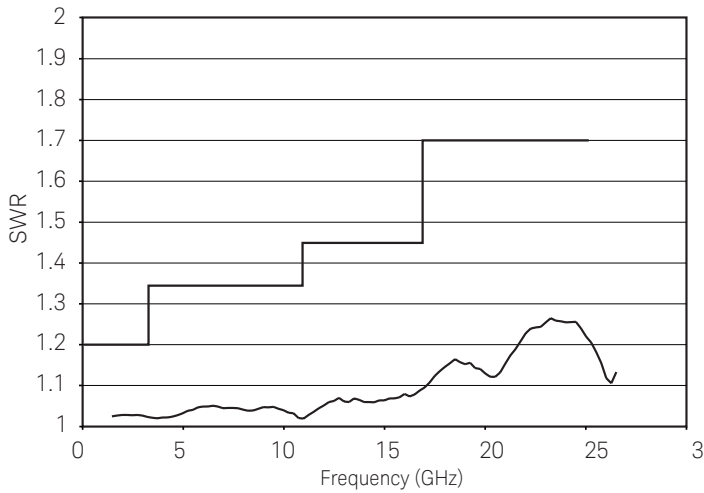

Figure 13. Keysight L-Series multiport switch SWR versus frequency

Environmental specifications	
Operating temperature	-25 to 75 °C
Storage temperature	-55 to 85 °C
Temperature cycling	-55 to 85 °C, 10 cycles per MIL-STD-202F, Method 107D, Condition A (modified)
Vibration	
Operating	7 g: 5 to 2000 Hz at 0.25 in p-p
Survival	20 g: 20 to 2000 Hz at 0.06 in p-p, 4 min/cycle, 4 cycles/axis
Random	2.41 g (rms) 10 min/axis
Shock	
Half-sine	500 g at 0.5 ms, 3 drops/direction, 18 total
Operating	50 g at 6 ms, 6 directions
Moisture resistance	65 °C, 95% RH, 10 days per MIL-STD-202F, Method 106E
Altitude storage	50,000 feet (15,240 meters per MIL-STD-202F, Method 105C, Condition B)
RFI	Radiated Emission per CISPR 11
Magnetic field	< 5 gauss 1/4 inch from surface

Specifications

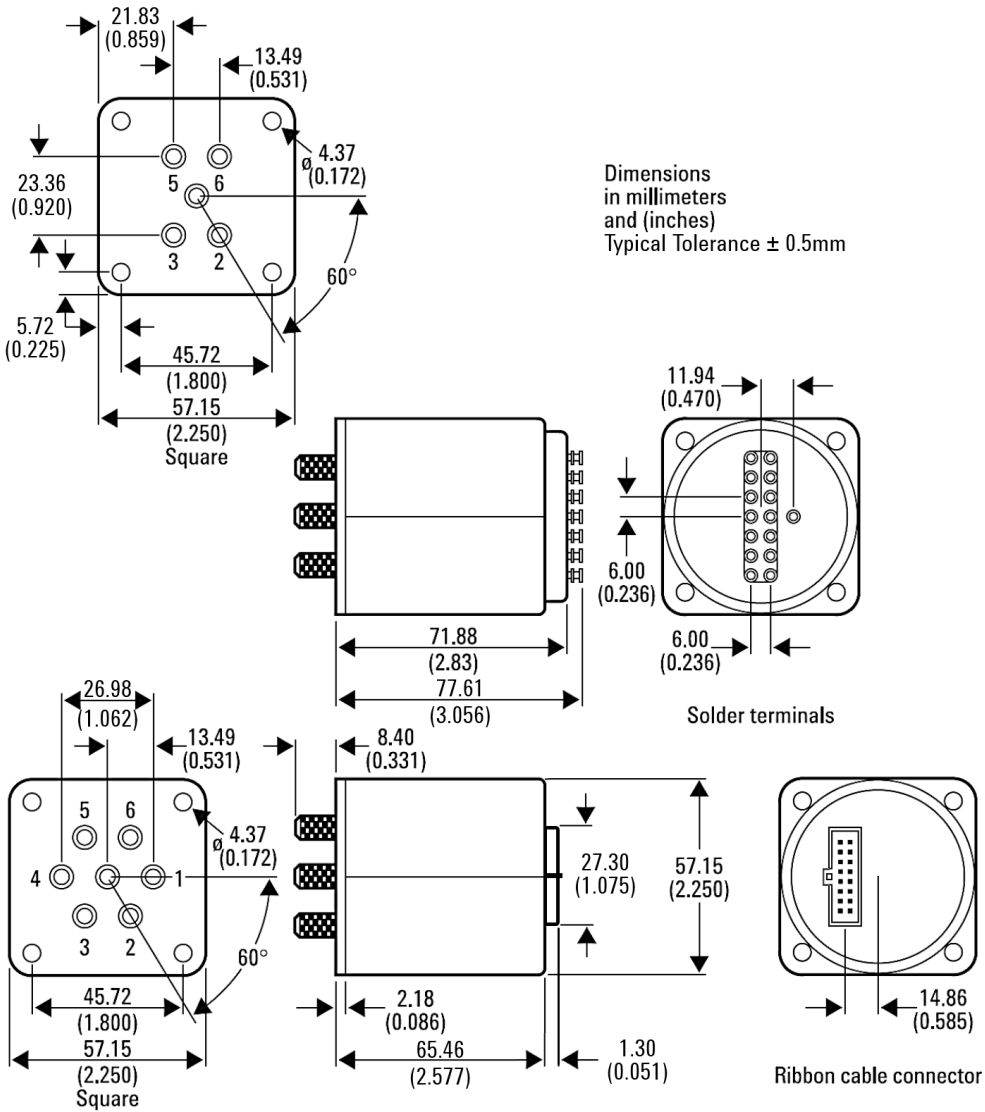

Figure 14. Product dimensions for L7104/106 A,B,C and L7204/206 A,B,C

Specifications

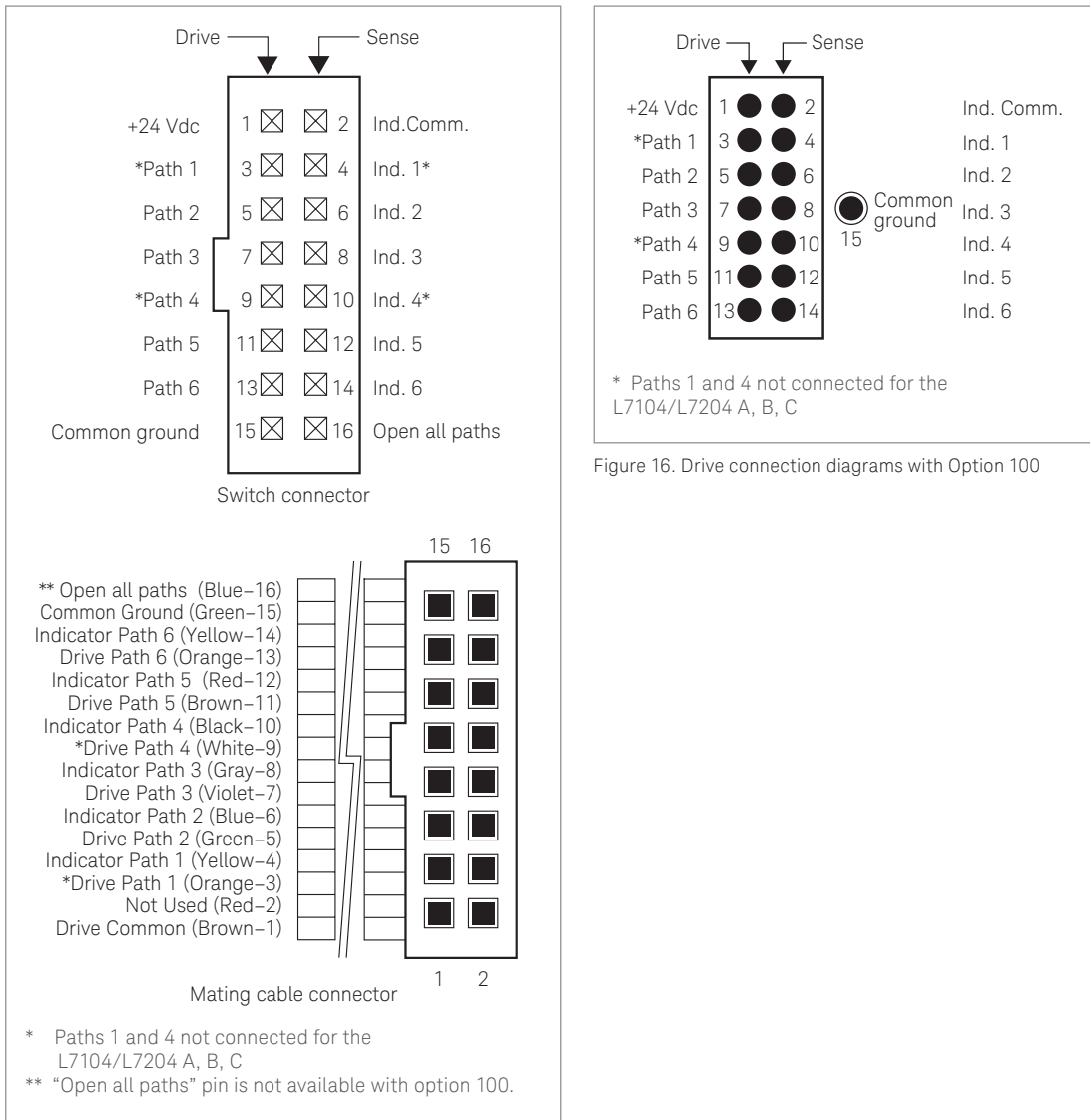

Figure 15. Drive connection diagrams with Option 161

Figure 16. Drive connection diagrams with Option 100

Troubleshooting

Symptom	Probable cause
1. Will not switch	<ul style="list-style-type: none"> – Not connected to supply – Supply < 20 V – Supply current too low – Not connected to ground – Select line not at ground (std) – TTL "Low" voltage too high (Option T24) – All-path-open line selected
2. Position indicators do not work	<ul style="list-style-type: none"> – Supply not connected – Supply < 20 VDC – Pin 15 not connected to ground

Ordering Information

Switch	
L7104A	DC to 4 GHz, SP4T terminated
L7104B	DC to 20 GHz, SP4T terminated
L7104C	DC to 26.5 GHz, SP4T terminated
L7204A	DC to 4 GHz, SP4T unterminated
L7204B	DC to 20 GHz, SP4T unterminated
L7204C	DC to 26.5 GHz, SP4T unterminated
L7106A	DC to 4 GHz, SP6T terminated
L7106B	DC to 20 GHz, SP6T terminated
L7106C	DC to 26.5 GHz, SP6T terminated
L7206A	DC to 4 GHz, SP6T unterminated
L7206B	DC to 20 GHz, SP6T unterminated
L7206C	DC to 26.5 GHz, SP6T unterminated
Option 100	Solder terminals to replace ribbon cable
Option 161	16 PIN DIP socket and connector with 24 inch ribbon cable
Option UK6	Commercial calibration test data with certificate
Option T24	TTL/5 V CMOS compatible option
Option 024	24 V DC without TTL logic

Note: 024 and 161 are default options for dc drive and connector.

Drivers	
11713B/C Attenuator switch driver	Drive up to 20 sections of switches or attenuators.
Cables	
Option 201 Accessory cable	Viking connector to bare tinned wires (60 inches long). Use to connect 11713B/C to L7104/204/106/206 with Option 100. One required with L7104/L7204 Option 100; two required with L7106/L7206 Option 100.
Option 401 Accessory cable	Dual-viking connector to 16-pin DIP connector. Use to connect 11713B/C to L7106/206 default Option 161.
Option 601 Accessory cable	Viking connector to 16-pin DIP connector. Use to connect 11713B/C to L7104/L7204 default Option 161.

Related literature

Publication title	Pub number
Keysight 11713B/C Attenuator/Switch Drivers Configuration Guide	5989-7277EN

Evolving Since 1939

Our unique combination of hardware, software, services, and people can help you reach your next breakthrough. We are unlocking the future of technology.
 From Hewlett-Packard to Agilent to Keysight.

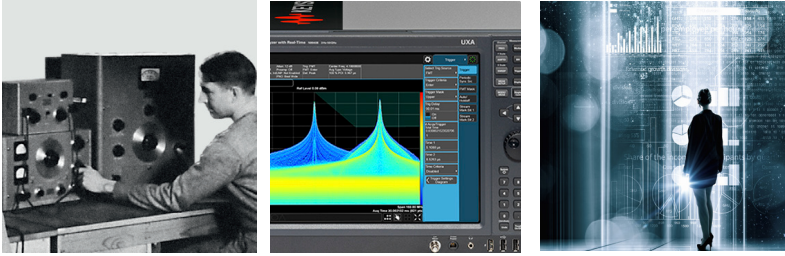

For more information on Keysight Technologies' products, applications or services, please contact your local Keysight office. The complete list is available at: www.keysight.com/find/contactus

Americas

Canada	(877) 894 4414
Brazil	55 11 3351 7010
Mexico	001 800 254 2440
United States	(800) 829 4444

Asia Pacific

Australia	1 800 629 485
China	800 810 0189
Hong Kong	800 938 693
India	1 800 11 2626
Japan	0120 (421) 345
Korea	080 769 0800
Malaysia	1 800 888 848
Singapore	1 800 375 8100
Taiwan	0800 047 866
Other AP Countries	(65) 6375 8100

Europe & Middle East

Austria	0800 001122
Belgium	0800 58580
Finland	0800 523252
France	0805 980333
Germany	0800 6270999
Ireland	1800 832700
Israel	1 809 343051
Italy	800 599100
Luxembourg	+32 800 58580
Netherlands	0800 0233200
Russia	8800 5009286
Spain	800 000154
Sweden	0200 882255
Switzerland	0800 805353
	Opt. 1 (DE)
	Opt. 2 (FR)
	Opt. 3 (IT)
United Kingdom	0800 0260637

For other unlisted countries:
www.keysight.com/find/contactus
 (BP-9-7-17)

DEKRA Certified
ISO 9001 Quality Management System

www.keysight.com/go/quality
 Keysight Technologies, Inc.
 DEKRA Certified ISO 9001:2015
 Quality Management System

myKeysight

myKeysight

www.keysight.com/find/mykeysight

A personalized view into the information most relevant to you.

http://www.keysight.com/find/emt_product_registration

Register your products to get up-to-date product information and find warranty information.

KEYSIGHT SERVICES
 Accelerate Technology Adoption.
 Lower costs.

Keysight Services

www.keysight.com/find/service

Keysight Services can help from acquisition to renewal across your instrument's lifecycle. Our comprehensive service offerings—one-stop calibration, repair, asset management, technology refresh, consulting, training and more—helps you improve product quality and lower costs.

Keysight Assurance Plans

www.keysight.com/find/AssurancePlans

Up to ten years of protection and no budgetary surprises to ensure your instruments are operating to specification, so you can rely on accurate measurements.

Keysight Channel Partners

www.keysight.com/find/channelpartners

Get the best of both worlds: Keysight's measurement expertise and product breadth, combined with channel partner convenience.

www.keysight.com/find/mta



Unlocking Measurement Insights

This information is subject to change without notice.
 © Keysight Technologies, 2017
 Published in USA, December 1, 2017
 5989-6030EN
www.keysight.com